

DESCRIPTIF TECHNIQUE

COLORIS

TOP - VERRE

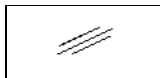

BLANC, VERRE
LAQUÉ LACOBEL

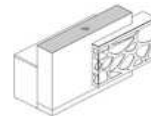

CORPS



67 BLANC PASTEL

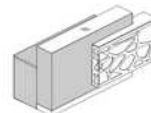

FAÇADE - MÉTAL



M015 BLANC
SEMI-MATE

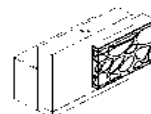

FAÇADE - PLEXIGLASS

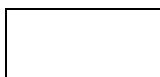

PLEXIGLASS
BLANC

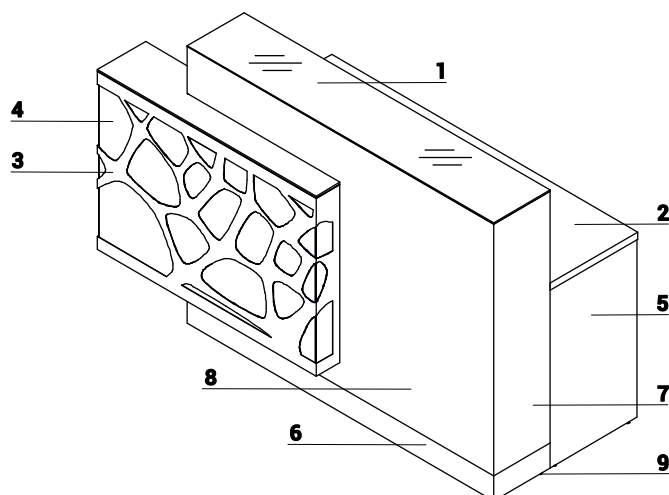
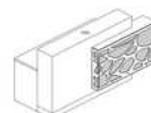

1. **Plateau verre** - LACOBEL 4mm
2. **Plan de travail** - mélaminé 28mm, chants PVC
3. **Façade** - élément en métal peinture poudre et plexi
4. **Eclairage RGBW LED** - télécommande
5. **Pied bas** - mélaminé 28mm, chants PVC
6. **Socle** - stratifié - aluminium brossé
7. **Corps** - plateau 18mm recouvert de stratifié - stratifié mat
8. **Façade** - plateau 28mm + stratifié mat 0,8mm
9. **Vérins** - réglage sur 5mm

DESCRIPTIF TECHNIQUE

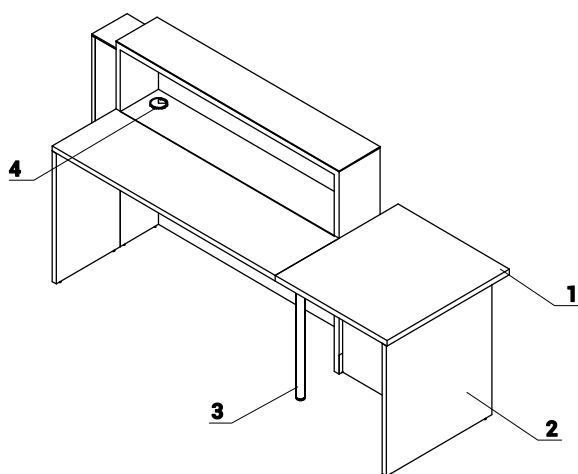

1. **Plan de travail** - mélaminé 28mm, chants PVC
2. **Pied bas** - mélaminé 28mm, chants PVC
3. **Pied de support NE41** - en métal, nécessaire pour la jonction des plateaux
4. **Obturateurs** - Ø80mm

DIMENSIONS

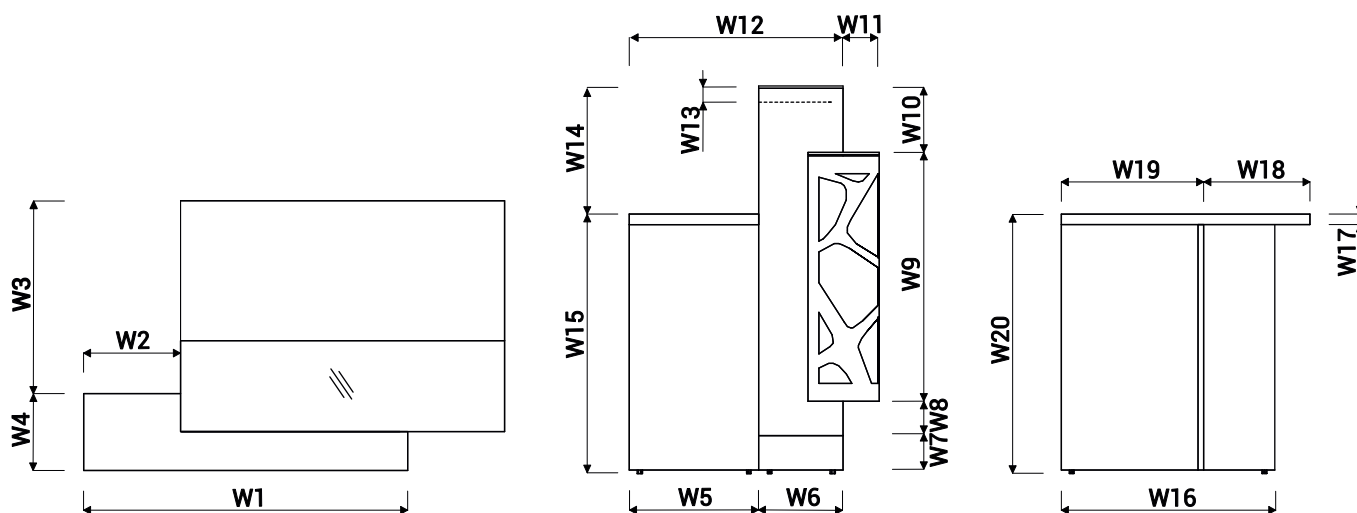

W1 - 1000mm | W2 - 300mm | W3 - 550mm | W4 - 222mm | W5 - 400mm | W6 - 260mm | W7 - 100mm | W8 - 97mm | W9 - 705mm | W10 - 184mm |
 W11 - 110mm | W12 - 660mm | W13 - 34mm | W14 - 365mm | W15 - 740mm | W16 - 660mm | W17 - 28mm | W18 - 318mm | W19 - 452mm | W20 -
 740mm

MODULES DE BANQUES

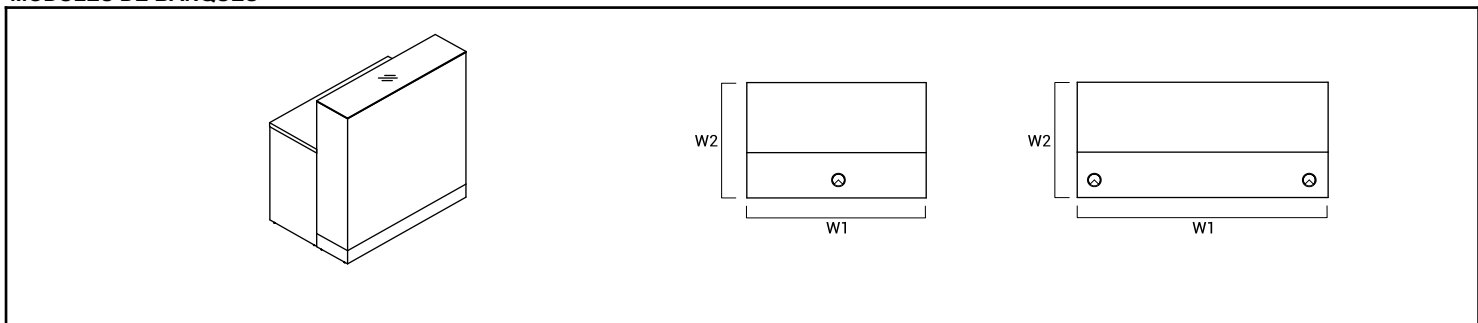

REF.	DIMENSIONS [mm]						⚖️	📦	📦		ELEMENTS DE COMPOSITION
	W ₁	W ₂	D ₁	D ₂	H						
LOG10G	1000	660			1105		50.0	0.582	2		LOG10B+LOG10K
LOG14G	1400	660			1105		55.0	0.815	2		LOG14B+LOG14K

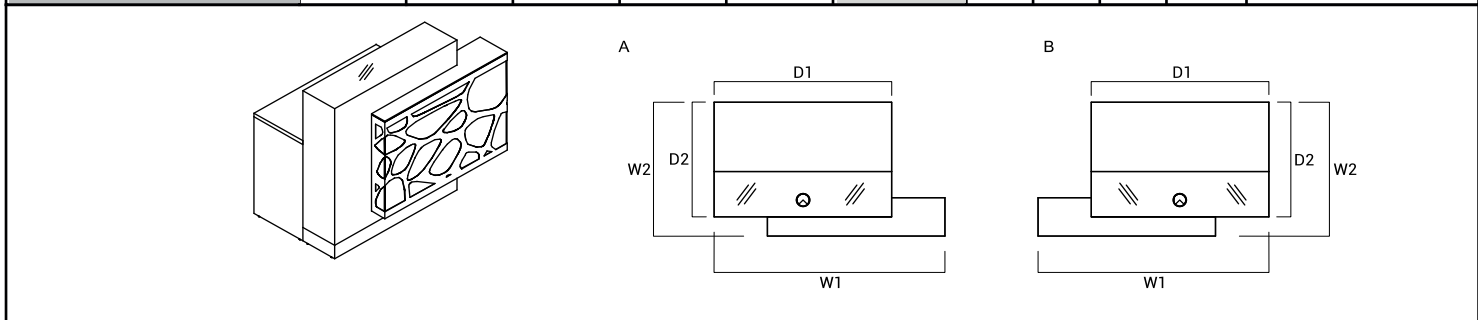

REF.	DIMENSIONS [mm]						⚖️	📦	📦		ELEMENTS DE COMPOSITION
	W ₁	W ₂	D ₁	D ₂	H						
A LOG11LG	1300	770	1000	660	1105		75.5	0.740	4		LOG10B+LOG10K+LOG01L
B LOG11PG	1300	770	1000	660	1105		75.5	0.740	4		LOG10B+LOG10K+LOG01P

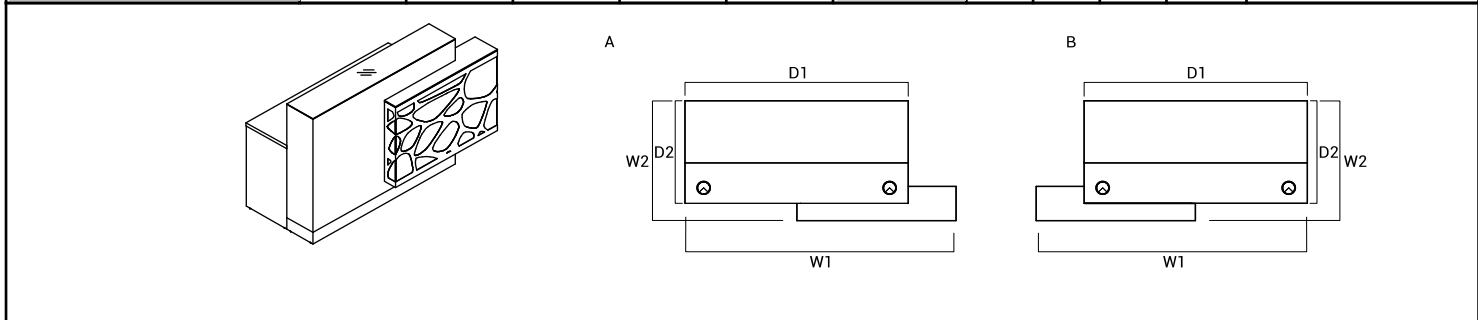

REF.	DIMENSIONS [mm]						⚖️	📦	📦		ELEMENTS DE COMPOSITION
	W ₁	W ₂	D ₁	D ₂	H						
A LOG12LG	1700	770	1400	660	1105		80.5	0.973	4		LOG14B+LOG14K+LOG01L
B LOG12PG	1700	770	1400	660	1105		80.5	0.973	4		LOG14B+LOG14K+LOG01P

LÉGENDE:

⚖️ POIDS NET

📦 VOLUME

📦 NOMBRE DE COLIS

MODULES DE BANQUES

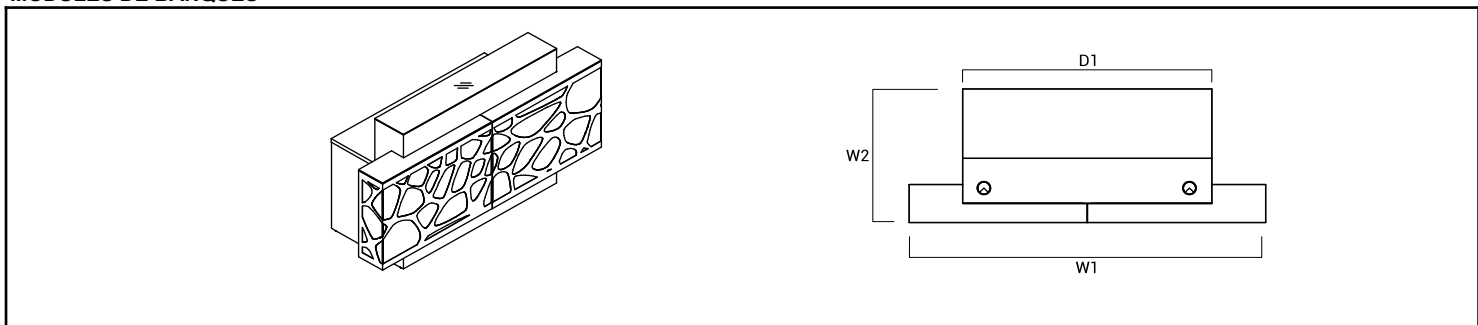

REF.	DIMENSIONS [mm]										ELEMENTS DE COMPOSITION
	W ₁	W ₂	D ₁	D ₂	H						
LOG13G	2000	770	1400	-	1105		106.0	1.132	6		LOG14B+LOG14K+LOG01L+LOG01P

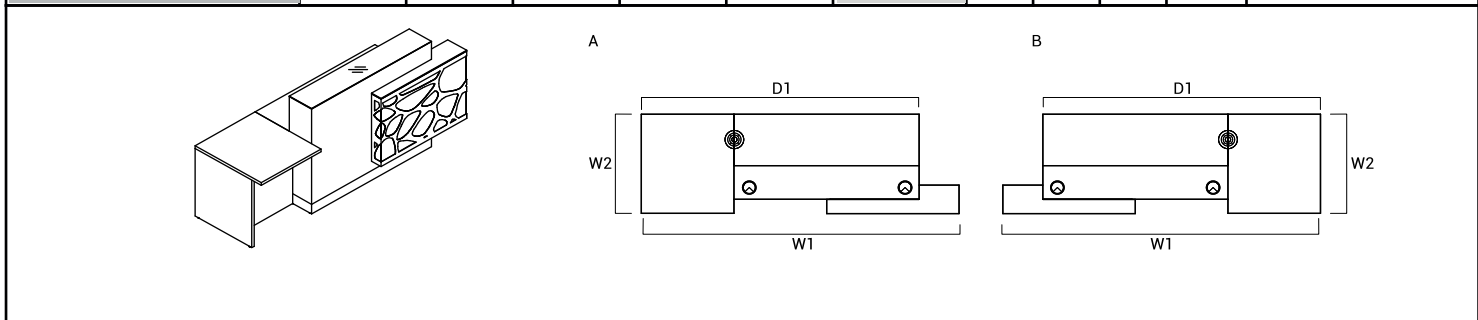

REF.	DIMENSIONS [mm]										ELEMENTS DE COMPOSITION
	W ₁	W ₂	D ₁	D ₂	H						
A LOG14PLG	2400	770	2100	-	1105		93.8	1.007	6		LOG01L+LOG14K+LOG14B+LOG07+NE41L
B LOG14PPG	2400	770	2100	-	1105		93.8	1.007	6		LOG07+LOG14B+LOG14K+LOG01P+NE41L

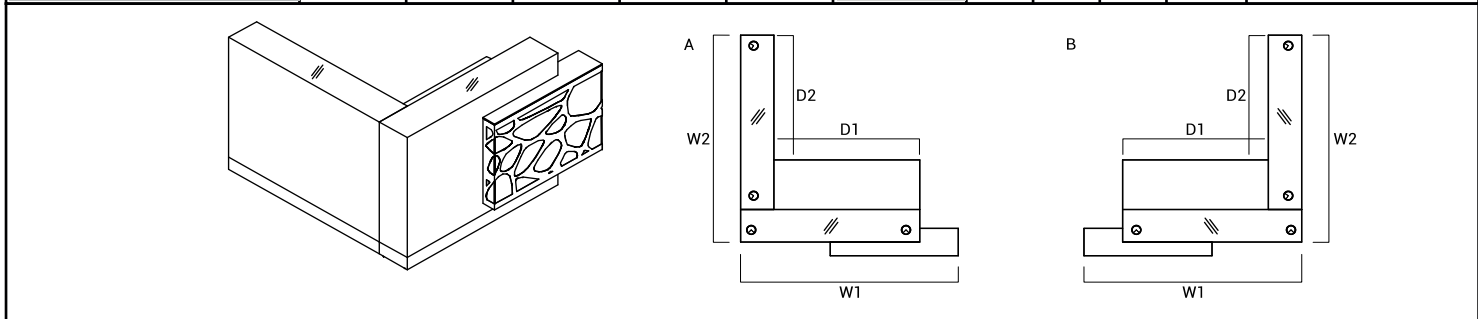

REF.	DIMENSIONS [mm]										ELEMENTS DE COMPOSITION
	W ₁	W ₂	D ₁	D ₂	H						
A LOG16LG	1700	1660	1140	1000	1105		120.5	1.297	5		LOG01L+2xLOG14K+LOG11B
B LOG16PG	1700	1770			1105		120.5	1.297	5		2xLOG14K+LOG11B+LOG01P

LÉGENDE:

POIDS NET

VOLUME

NOMBRE DE COLIS

MODULES DE BANQUES

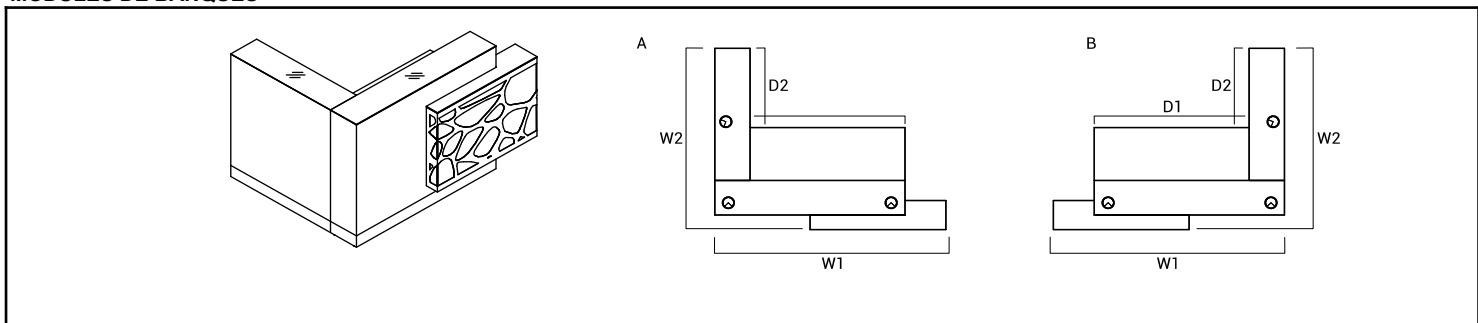

REF.	DIMENSIONS [mm]					kg	m3	pcs	ELEMENTS DE COMPOSITION
	W1	W2	D1	D2	H				
A LOG18LG	1700	1370	1140	600	1105	115.5	1.182	5	LOG01L+LOG14K+LOG11B+LOG10K
B LOG18PG	1700	1370			1105	115.5	1.182	5	LOG10K+LOG11B+LOG14K+LOG01P

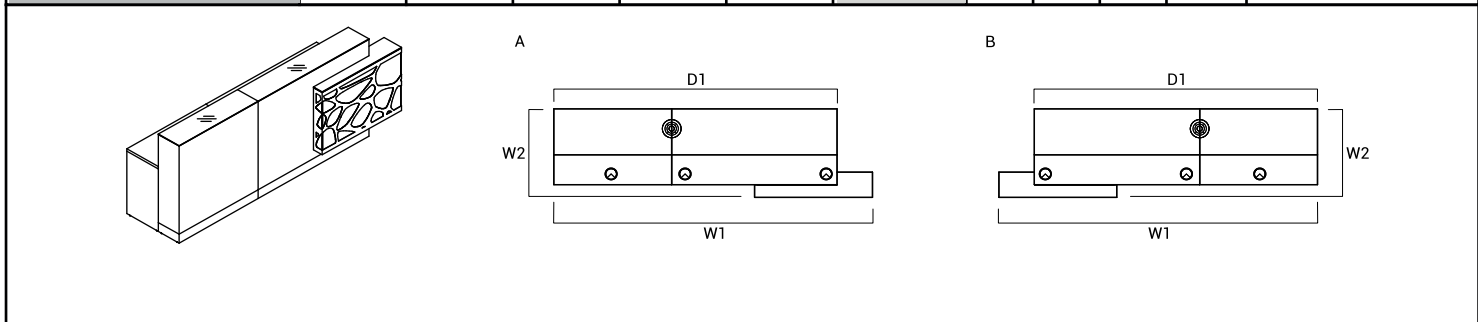

REF.	DIMENSIONS [mm]					kg	m3	pcs	ELEMENTS DE COMPOSITION
	W1	W2	D1	D2	H				
A LOG19LG	2700	770	2400	-	1105	131.8	1.557	7	LOG01L+LOG14K+LOG10K+LOG14B+LOG10B+NE41L
B LOG19PG	2700	770	2400	-	1105	131.8	1.557	7	LOG10B+LOG14B+LOG10K+LOG14K+LOG01P+NE41L

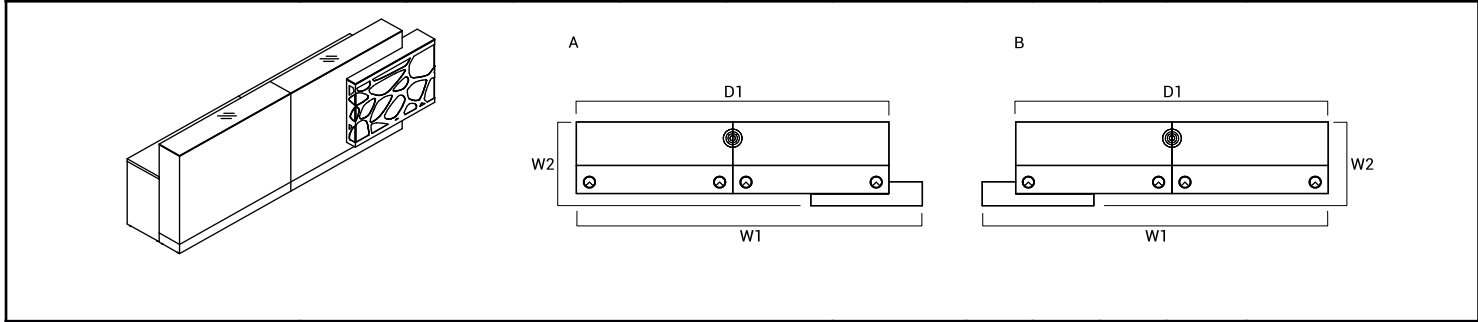

REF.	DIMENSIONS [mm]					kg	m3	pcs	ELEMENTS DE COMPOSITION
	W1	W2	D1	D2	H				
A LOG20LG	3100	770	2800	-	1105	136.8	1.790	7	LOG01L+2xLOG14K+2xLOG14B+NE41L
B LOG20PG	3100	770	2800	-	1105	136.8	1.790	7	2xLOG14B+2xLOG14K+LOG01P+NE41L

LÉGENDE:

POIDS NET

VOLUME

NOMBRE DE COLIS

MODULES DE BANQUES

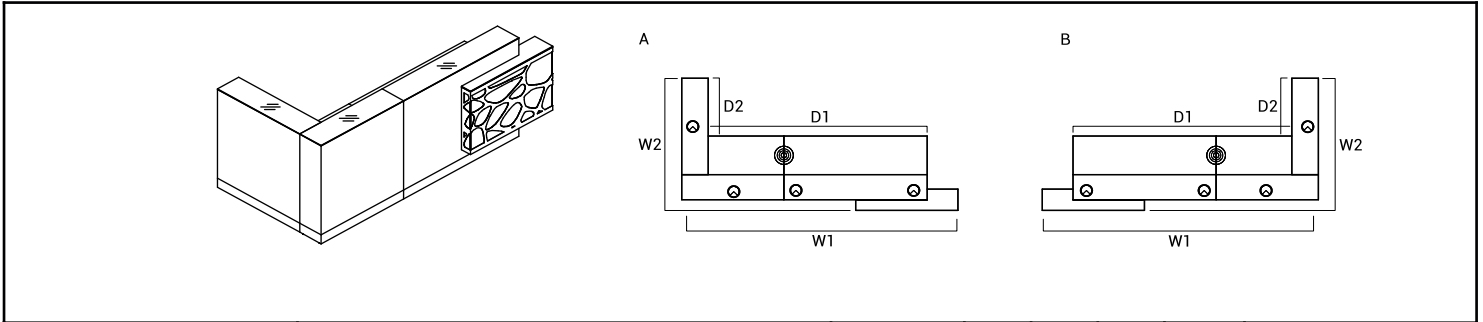

REF.	DIMENSIONS [mm]					kg	m3	pcs	ELEMENTS DE COMPOSITION
	W ₁	W ₂	D ₁	D ₂	H				
A LOG21LG	2700	1370	2140	600	1105	162.8	1.555	8	LOG01L+LOG14K+2xLOG10K+LOG14B+LOG08B+NE41L
B LOG21PG	2700	1370	2140	600	1105	162.8	1.555	8	2xLOG10K+LOG08B+LOG14B+LOG14K+LOG01P+NE41L

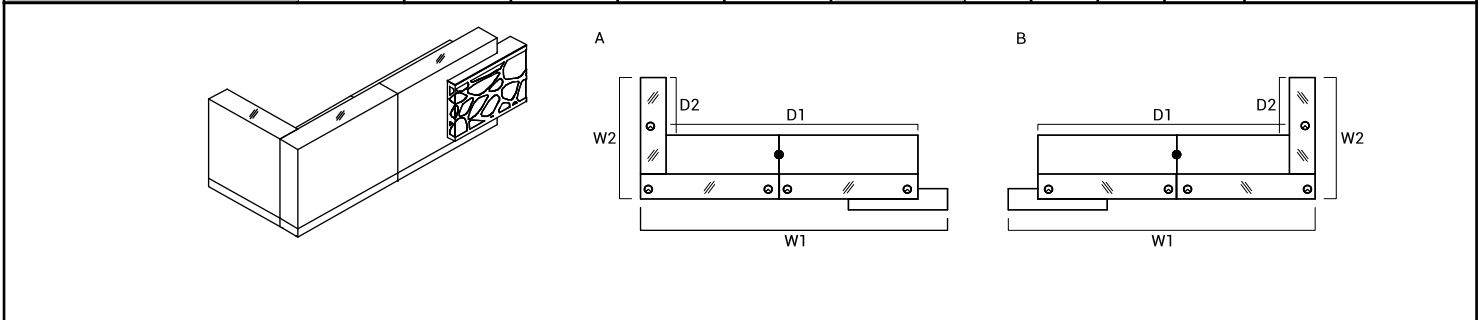

REF.	DIMENSIONS [mm]					kg	m3	pcs	ELEMENTS DE COMPOSITION
	W ₁	W ₂	D ₁	D ₂	H				
A LOG22LG	3100	1370	2540	600	1105	171.8	1.999	8	LOG01L+2xLOG14K+LOG14B+LOG11B+LOG10K+NE41L
B LOG22PG	3100	1370	2540	600	1105	171.8	1.999	8	LOG10K+LOG11B+LOG14B+2xLOG14K+LOG01P+NE41L

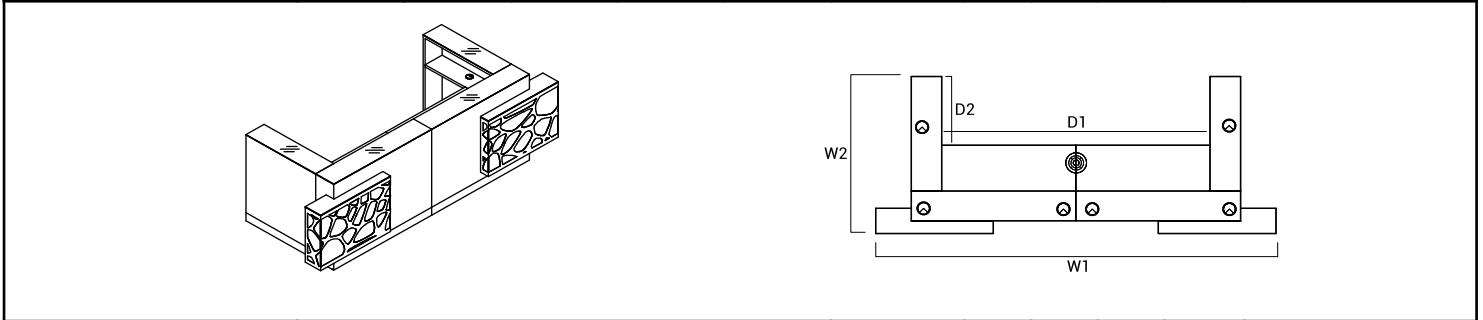

REF.	DIMENSIONS [mm]					kg	m3	pcs	ELEMENTS DE COMPOSITION
	W ₁	W ₂	D ₁	D ₂	H				
LOG23G	3400	1370	2280	600	1105	232.3	2.366	11	2xLOG10K+2xLOG11B+2xLOG14K+LOG01L+LOG01P+NE41L

LÉGENDE:

POIDS NET

VOLUME

NOMBRE DE COLIS

MODULES DE BANQUES

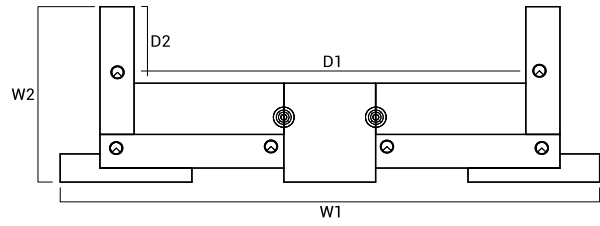
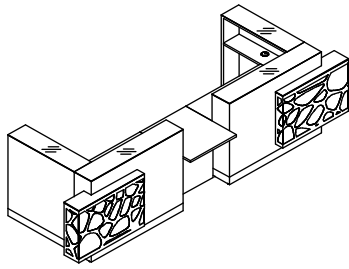

REF.	DIMENSIONS [mm]						kg	m3	pcs	ELEMENTS DE COMPOSITION
	W ₁	W ₂	D ₁	D ₂	H					
LOG24G	4100	1370			1105		245.6	2.401	13	2xLOG10K+2xLOG14K+2xLOG11B +LOG07+LOG01L+LOG01P +2xNE41L

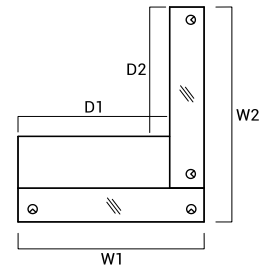
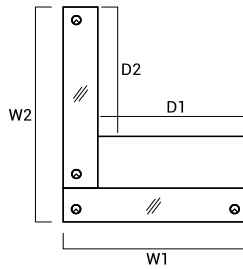
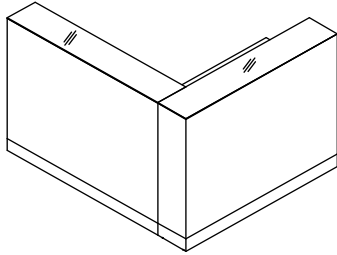

REF.	DIMENSIONS [mm]						kg	m3	pcs	ELEMENTS DE COMPOSITION
	W ₁	W ₂	D ₁	D ₂	H					
LOG15	1400	1660			1105		95.0	1.138	3	2xLOG14K+LOG11B

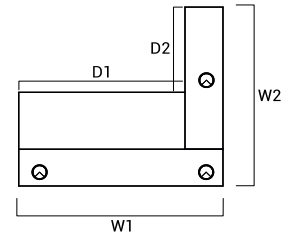
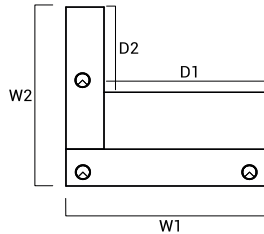
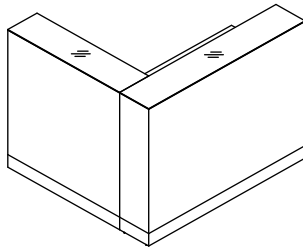

REF.	DIMENSIONS [mm]						kg	m3	pcs	ELEMENTS DE COMPOSITION
	W ₁	W ₂	D ₁	D ₂	H					
LOG17	1400	1260			1105		90.0	1.024	3	LOG11B+LOG14K+LOG10K

LÉGENDE:

POIDS NET

VOLUME

NOMBRE DE COLIS

MODULES DE BANQUES

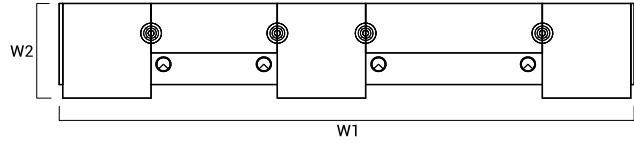
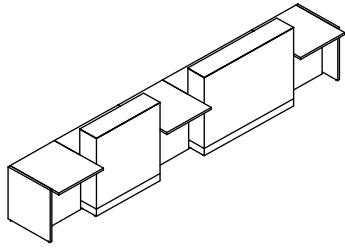



REF.	DIMENSIONS [mm]									ELEMENTS DE COMPOSITION
	W ₁	W ₂	D ₁	D ₂	H		kg	m ³	pcs	
LOG25	4556	770			1105		146.2	1.501	11	3xLOG07+LOG14B+LOG14K +LOG10B+LOG10K+4xNE41L

LÉGENDE:







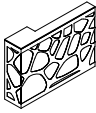
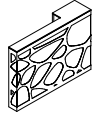

POIDS NET

VOLUME

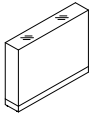
NOMBRE DE COLIS

VUE DU PRODUIT	DIMENSIONS [mm]			REF.						REMARQUES
	LONGEUR	PROFONDEUR	HAUTEUR			kg	m3	pcs		

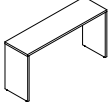
ELEMENTS DE COMPOSITION

	728	770	740	LOG07		13.3	0.034	2		élément universel
	1000	220	710	LOG01P		25.5	0.158	2		droite
	1000	220	710	LOG01L		25.5	0.158	2		gauche
	1000	260	1105	LOG10K		35.0	0.286	1		
	1400	260	1105	LOG14K		40.0	0.400	1		
	740	400	28	LOG08B		11.0	0.008	1		
	1000	400	740	LOG10B		15.0	0.296	1		
	1140	400	740	LOG11B		15.0	0.337	1		
	1400	400	740	LOG14B		15.0	0.414	1		
	40	40	712	NE41L		1.5	0.002	1		ped tube

LÉGENDE:

 POIDS NET

 VOLUME

 NOMBRE DE COLIS