

Symbol		Wymiary					Waga Obj. Opak.	Elementy składowe
		W1	W2	D1	D2	H		
LOG10G		1000	660			1105	50 kg 0.582 m3 2 szt.	LOG10B+LOG10K
LOG14G		1400	660			1105	67 kg 0.815 m3 2 szt.	LOG14B+LOG14K

Dodatkowa dopłata						

Symbol		Wymiary					Waga Obj. Opak.	Elementy składowe
		W1	W2	D1	D2	H		
A	B	1300	770	1000	660	1105	75.5 kg 0.74 m3 4 szt.	A - LOG10B+LOG10K+LOG01L B - LOG10B+LOG10K+LOG01P

Dodatkowa dopłata						

Symbol		Wymiary					Waga Obj. Opak.	Elementy składowe
		W1	W2	D1	D2	H		
A	B	1700	770	1400	660	1105	92.5 kg 0.973 m3 4 szt.	A - LOG14B+LOG14K+LOG01L B - LOG14B+LOG14K+LOG01P

Dodatkowa dopłata						

Symbol		Wymiary					Waga Obj. Opak.	Elementy składowe
		W1	W2	D1	D2	H		
LOG13G		2000	770	1400		1105	118 kg 1.132 m ³ 6 szt.	LOG14B+LOG14K+LOG01L+LOG01P

Dodatkowa dopłata					

Symbol		Wymiary					Waga Obj. Opak.	Elementy składowe
		W1	W2	D1	D2	H		
LOG14PLG	LOG14PPG	2400	770	2100		1105	106 kg 1.007 m ³ 6 szt.	A - LOG01L+LOG14K+LOG14B+LOG07+NE41L B - LOG07+LOG14B+LOG14K+LOG01P+NE41L

Dodatkowa dopłata					

Symbol		Wymiary					Waga Obj. Opak.	Elementy składowe
		W1	W2	D1	D2	H		
LOG16LG	LOG16PG	1700	1770	1140	1000	1105	134.5 kg 1.297 m ³ 5 szt.	A - LOG01L+2xLOG14K+LOG11B B - 2xLOG14K+LOG11B+LOG01P

Dodatkowa dopłata					

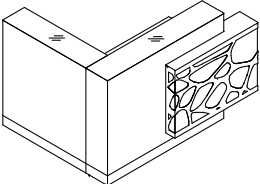

A

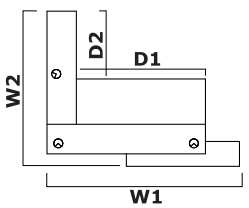

B

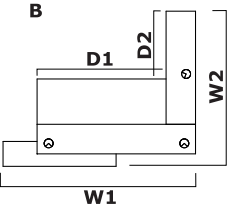

Symbol			Wymiary					Waga Obj. Opak.	Elementy składowe
A	B		W1	W2	D1	D2	H		
LOG18LG	LOG18PG		1700	1370	1140	600	1105	122.5 kg 1.182 m ³ 5 szt.	A - LOG01L+LOG14K+LOG11B+LOG10K B - LOG10K+LOG11B+LOG14K+LOG01P

Dodatkowa dopłata					

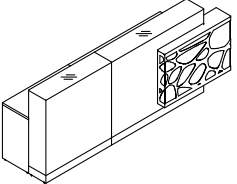

A

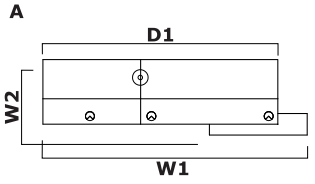

B

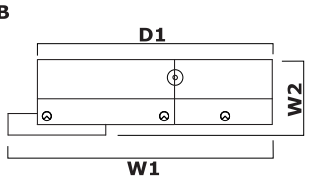

Symbol			Wymiary					Waga Obj. Opak.	Elementy składowe
A	B		W1	W2	D1	D2	H		
LOG19LG	LOG19PG		2700	770	2400		1105	144 kg 1.557 m ³ 7 szt.	A - LOG01L+LOG14K+LOG10K+LOG14B+LOG10B+NE41L B - LOG10B+LOG14B+LOG10K+LOG14K+LOG01P+NE41L

Dodatkowa dopłata					

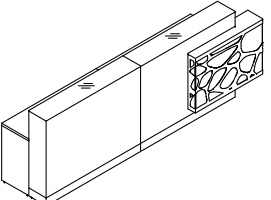

A

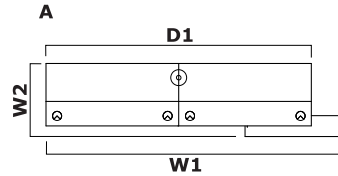

B

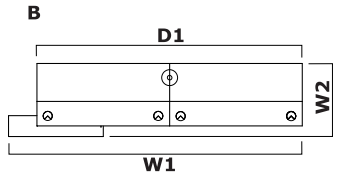

Symbol			Wymiary					Waga Obj. Opak.	Elementy składowe
A	B		W1	W2	D1	D2	H		
LOG20LG	LOG20PG		3100	770	2800		1105	161 kg 1.79 m ³ 7 szt.	A - LOG01L+2xLOG14K+2xLOG14B +NE41L B - 2xLOG14B+2xLOG14K+LOG01P +NE41L

Dodatkowa dopłata					

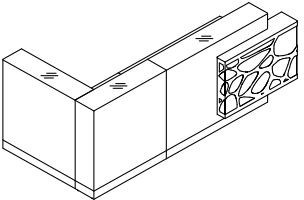

A

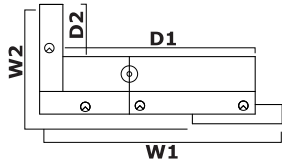

B

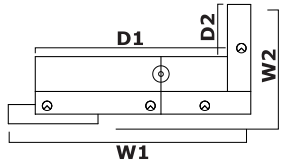

Symbol		Wymiary	Waga Obj. Opak.	Elementy składowe
A	B			
LOG21LG	LOG21PG	W1: 2700, W2: 1370, D1: 2140, D2: 600, H: 1105	175 kg 1.555 m ³ 8 szt.	A - LOG01L+LOG14K+2xLOG10K +LOG14B+LOG08B+NE41L B - 2xLOG10K+LOG08B+LOG14B +LOG14K+LOG01P+NE41L

Dodatkowa dopłata					

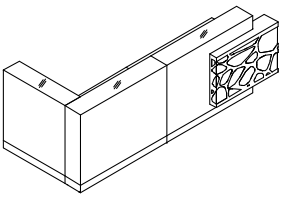

A

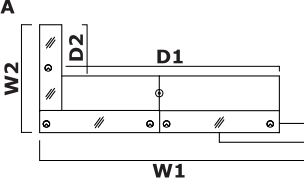

B

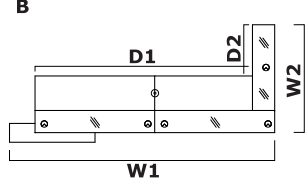

Symbol		Wymiary	Waga Obj. Opak.	Elementy składowe
A	B			
LOG22LG	LOG22PG	W1: 3100, W2: 1370, D1: 2540, D2: 600, H: 1105	191 kg 1.999 m ³ 8 szt.	A - LOG01L+2xLOG14K+LOG14B +LOG11B+LOG10K+NE41L B - LOG10K+LOG11B+LOG14B +2xLOG14K+LOG01P+NE41L

Dodatkowa dopłata					

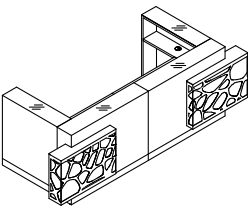

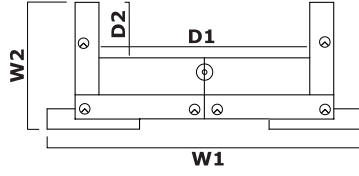

Symbol		Wymiary	Waga Obj. Opak.	Elementy składowe
LOG23G		W1: 3400, W2: 1370, D1: 2280, D2: 600, H: 1105	246.5 kg 2.366 m ³ 11 szt.	2xLOG10K+2xLOG11B+2xLOG14K+LOG01L+LOG01P+NE41L

Dodatkowa dopłata					

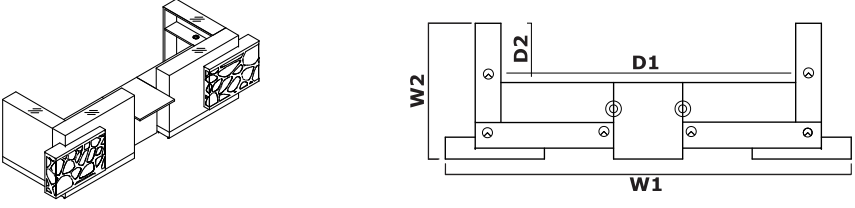
		Wymiary					Waga Obj. Opak.	Elementy składowe
		W1	W2	D1	D2	H		
LOG24G		4100	1370			1105	260 kg 2.401 m ³ 13 szt.	2xLOG10K+2xLOG14K+2xLOG11B+LOG07+LOG01L+LOG01P+2xNE41L

Dodatkowa dopłata						

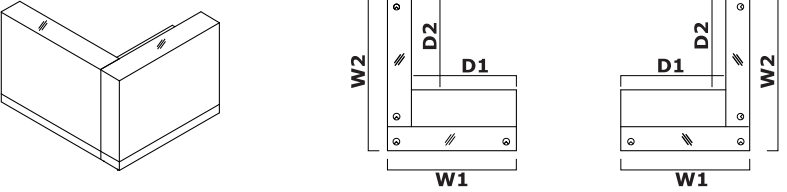
		Wymiary					Waga Obj. Opak.	Elementy składowe
		W1	W2	D1	D2	H		
LOG15		1400	1660			1105	109 kg 1.138 m ³ 3 szt.	2xLOG14K+LOG11B

Dodatkowa dopłata						

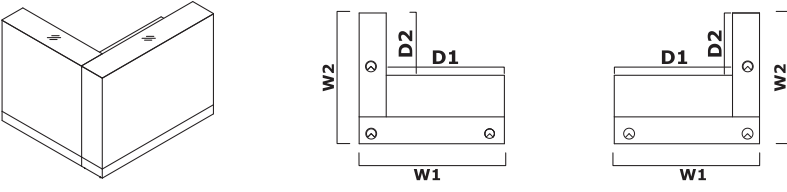
		Wymiary					Waga Obj. Opak.	Elementy składowe
		W1	W2	D1	D2	H		
LOG17		1400	1260			1105	97 kg 1.024 m ³ 3 szt.	LOG11B+LOG14K+LOG10K

Dodatkowa dopłata						

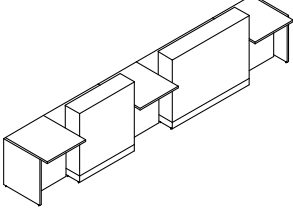
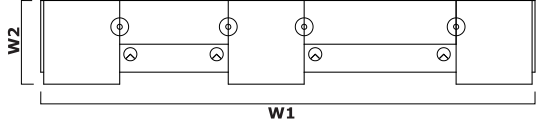
 		Wymiary					Waga Obj. Opak.	Elementy składowe
		W1	W2	D1	D2	H		
LOG25		4556	770			1105	159 kg 1.501 m3 11 szt.	3xLOG07+LOG14B+LOG14K +LOG10B+LOG10K+4xNE41L

Dodatkowa dopłata						

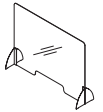
Elementy składowe							
	Symbol	Wymiary			Waga Obj. Opak.	Uwagi	
		Szer.	Gł.	Wys.			
	NPX1		1000	250	750	3 kg 0.01 m3 2 szt.	nadstawka ochronna, tworzywo PET bezbarwne + stopki metalowe, kolor: M009 - aluminium półmat

Dodatkowa dopłata							