

PIATO

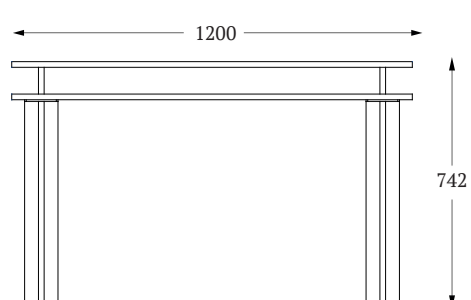

A

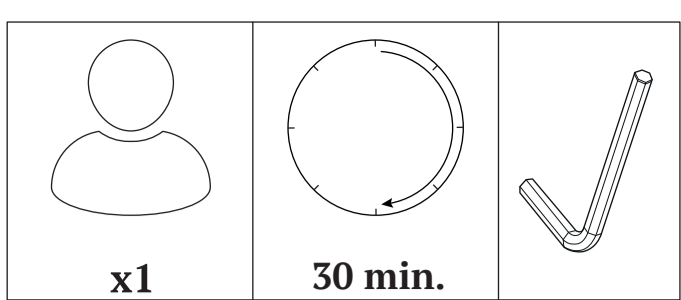
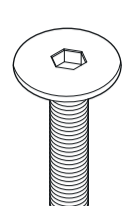

(WSI M6x15)
x16

B

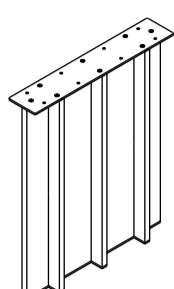

x2

C

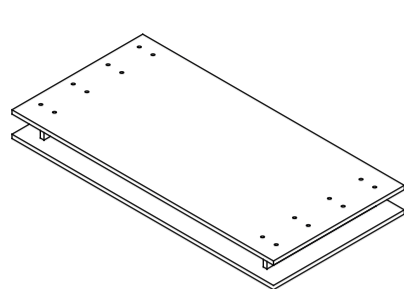

x1

1.

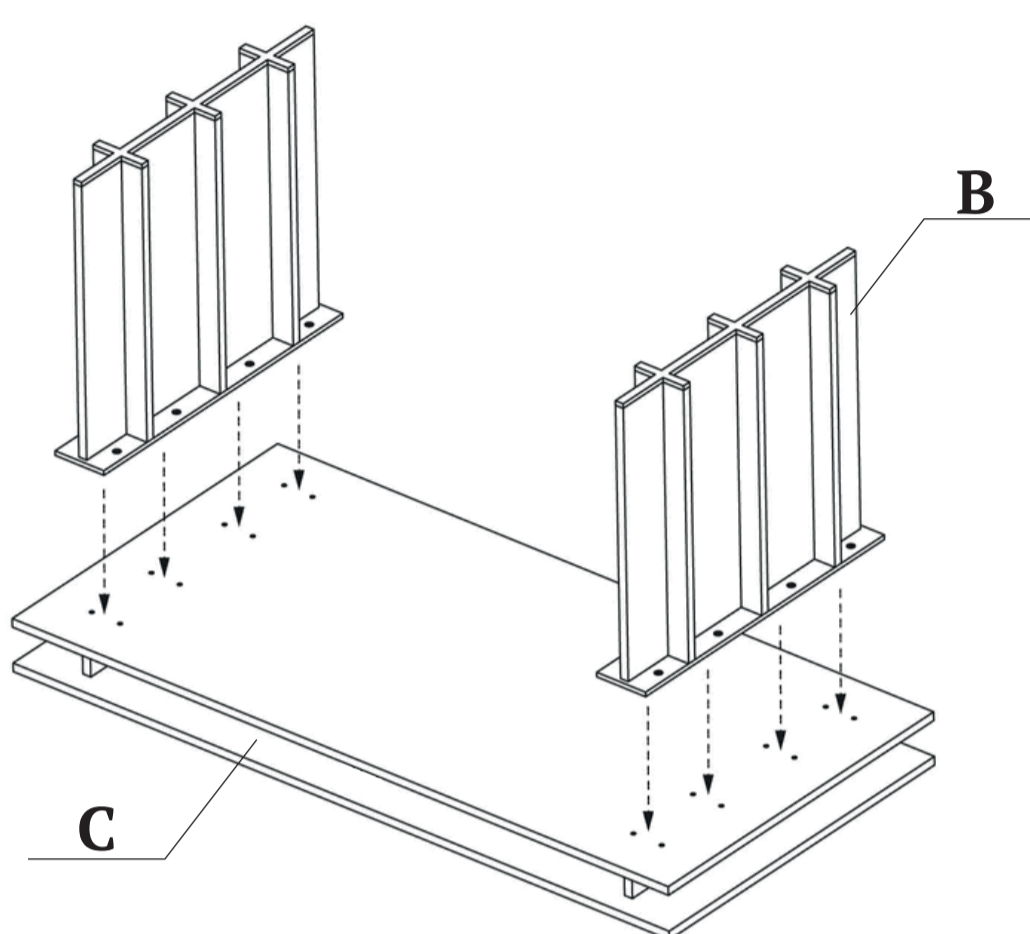

2.

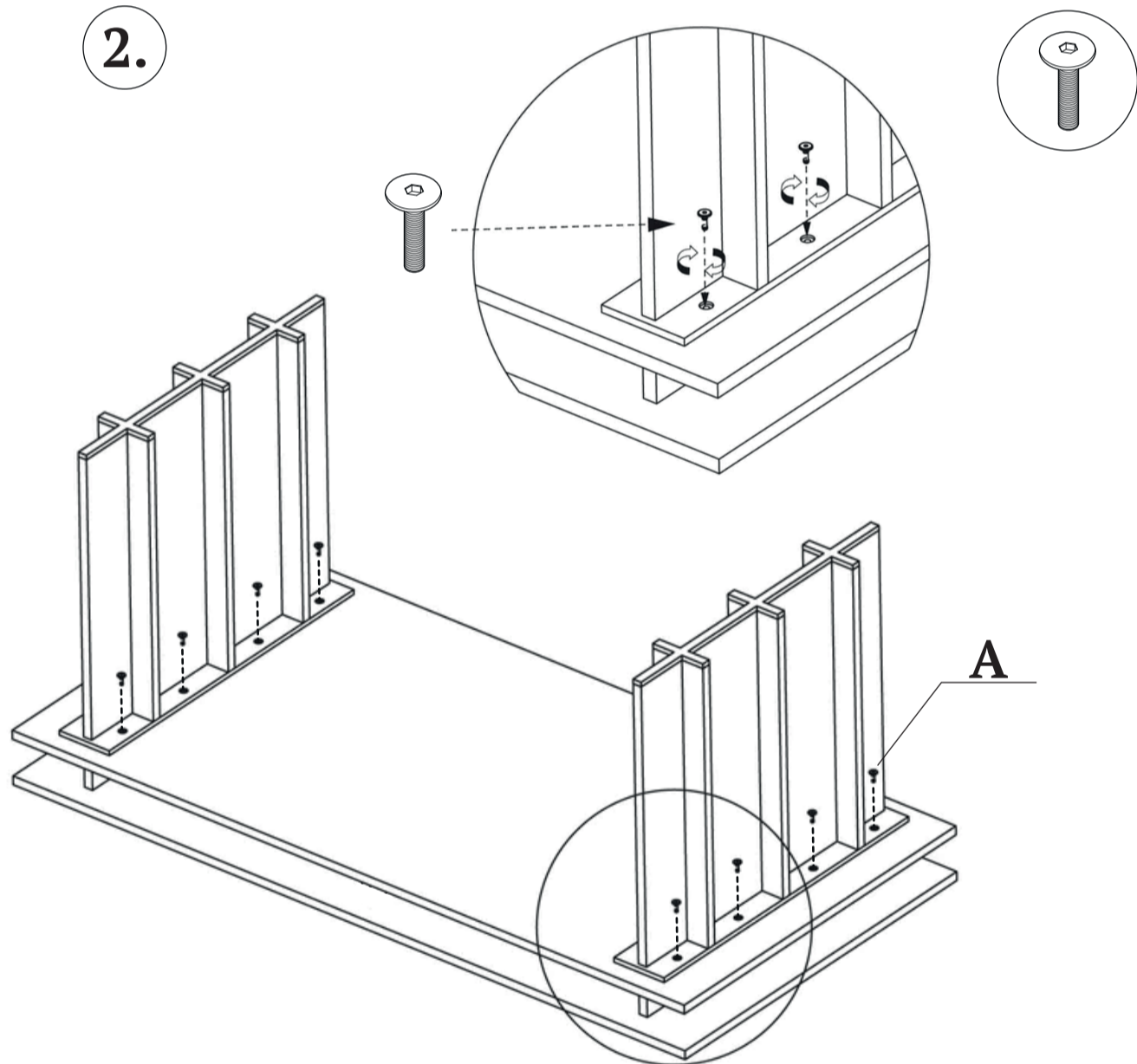

3.

