









	Symbol	Siedzisko tworzywo	Siedzisko tapicerowane			Kółka do powierzchni twardych	Waga Obj. Opak.	Informacje dodatkowe
			II	III	IV			
			Medley, **Atlantic, Vita, Mica, Go Check, Charles	Xtreme, Synergy, ***Silvertext, *tk. powierzona	Atlas, Field2, Skóra			
	<b>BL1P1</b>						6 0,232 1	
	<b>BL1P13</b>						8 0,232 1	
	<b>BL1P13K</b>						8 0,232 1	
	<b>BL1P14</b>						6 0,232 1	
	<b>BL2P1</b>						6 0,232 1	
	<b>BL2P13</b>						8 0,232 1	
	<b>BL2P13K</b>						8 0,232 1	
	<b>BL2P14</b>						6 0,232 1	

Wymiary (mm)

**BL1P1  
BL2P1**

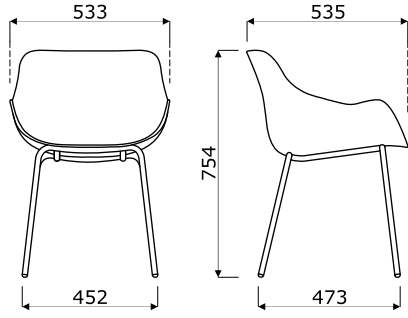

**BL1P13  
BL2P13**

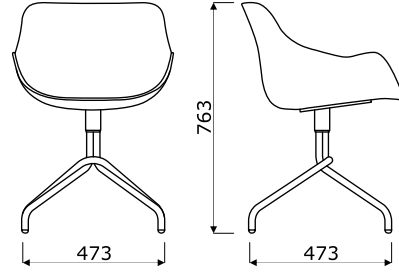

**BL1P13K  
BL2P13K**

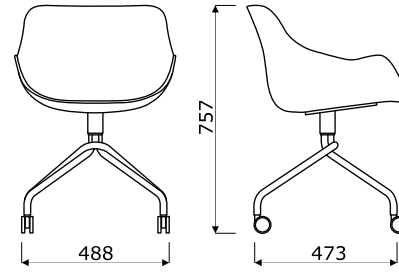

**BL1P14  
BL2P14**

